



**MOTOROLA**

Order this document by MC3346/D

# General Purpose Transistor Array One Differentially Connected Pair and Three Isolated Transistor Arrays

The MC3346 is designed for general purpose, low power applications for consumer and industrial designs.

- Guaranteed Base–Emitter Voltage Matching
- Operating Current Range Specified: 10  $\mu$ A to 10 mA
- Five General Purpose Transistors in One Package

## MC3346

### GENERAL PURPOSE TRANSISTOR ARRAY

#### SEMICONDUCTOR TECHNICAL DATA

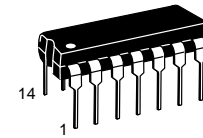

**P SUFFIX**  
PLASTIC PACKAGE  
CASE 646

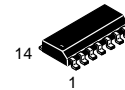

**D SUFFIX**  
PLASTIC PACKAGE  
CASE 751A  
(SO-14)

#### MAXIMUM RATINGS

Rating	Symbol	Value	Unit
Collector–Emitter Voltage	$V_{CEO}$	15	Vdc
Collector–Base Voltage	$V_{CBO}$	20	Vdc
Emitter–Base Voltage	$V_{EB}$	5.0	Vdc
Collector–Substrate Voltage	$V_{CIO}$	20	Vdc
Collector Current – Continuous	$I_C$	50	mAdc
Total Power Dissipation @ $T_A = 25^\circ\text{C}$ Derate above $25^\circ\text{C}$	$P_D$	1.2 10	W mW/ $^\circ\text{C}$
Operating Temperature Range	$T_A$	-40 to +85	$^\circ\text{C}$
Storage Temperature Range	$T_{stg}$	-65 to +150	$^\circ\text{C}$

#### ORDERING INFORMATION

Device	Operating Temperature Range	Package
MC3346D	$T_A = -40^\circ$ to $+85^\circ\text{C}$	SO-14
MC3356P		Plastic DIP

#### PIN CONNECTIONS

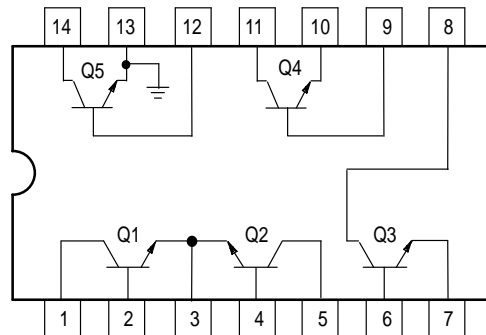

Pin 13 is connected to substrate and must remain at the lowest circuit potential.

# MC3346

## ELECTRICAL CHARACTERISTICS (T<sub>A</sub> = +25°C, unless otherwise noted.)

Characteristics	Symbol	Min	Typ	Max	Unit
<b>STATIC CHARACTERISTICS</b>					
Collector–Base Breakdown Voltage (I <sub>C</sub> = 10 μAdc)	V <sub>(BR)CBO</sub>	20	60	–	Vdc
Collector–Emitter Breakdown Voltage (I <sub>C</sub> = 1.0 mAdc)	V <sub>(BR)CEO</sub>	15	–	–	Vdc
Collector–Substrate Breakdown Voltage (I <sub>C</sub> = 10 μA)	V <sub>(BR)CIO</sub>	20	60	–	Vdc
Emitter–Base Breakdown Voltage (I <sub>E</sub> = 10 μAdc)	V <sub>(BR)EBO</sub>	5.0	7.0	–	Vdc
Collector–Base Cutoff Current (V <sub>CB</sub> = 10 Vdc, I <sub>E</sub> = 0)	I <sub>CBO</sub>	–	–	40	nAdc
DC Current Gain (I <sub>C</sub> = 10 mAdc, V <sub>CE</sub> = 3.0 Vdc) (I <sub>C</sub> = 1.0 mAdc, V <sub>CE</sub> = 3.0 Vdc) (I <sub>C</sub> = 10 μAdc, V <sub>CE</sub> = 3.0 Vdc)	h <sub>FE</sub>	– 40 –	140 130 60	– – –	–
Base–Emitter Voltage (V <sub>CE</sub> = 3.0 Vdc, I <sub>E</sub> = 1.0 mAdc) (V <sub>CE</sub> = 3.0 Vdc, I <sub>E</sub> = 10 mAdc)	V <sub>BE</sub>	– –	0.72 0.8	– –	Vdc
Input Offset Current for Matched Pair Q1 and Q2 (V <sub>CE</sub> = 3.0 Vdc, I <sub>C</sub> = 1.0 mAdc)	I <sub>O1</sub> – I <sub>O2</sub>	–	0.3	2.0	μAdc
Magnitude of Input Offset Voltage (V <sub>CE</sub> = 3.0 Vdc, I <sub>C</sub> = 1.0 mAdc)	–	–	0.5	5.0	mVdc
Temperature Coefficient of Base–Emitter Voltage (V <sub>CE</sub> = 3.0 Vdc, I <sub>C</sub> = 1.0 mAdc)	$\frac{\Delta V_{BE}}{D_T}$	–	–1.9	–	mV/°C
Temperature Coefficient	$\frac{ \Delta I_{IO} }{D_T}$	–	1.0	–	μV/°C
Collector–Emitter Cutoff Current (V <sub>CE</sub> = 10 Vdc, I <sub>B</sub> = 0)	I <sub>CEO</sub>	–	–	0.5	μAdc

## DYNAMIC CHARACTERISTICS

Low Frequency Noise Figure (V <sub>CE</sub> = 3.0 Vdc, I <sub>C</sub> = 100 μAdc, R <sub>S</sub> = 1.0 kΩ, f = 1.0 kHz)	NF	–	3.25	–	dB
Forward Current Transfer Ratio (V <sub>CE</sub> = 3.0 Vdc, I <sub>C</sub> = 1.0 mAdc, f = 1.0 kHz)	h <sub>FE</sub>	–	110	–	–
Short Circuit Input Impedance (V <sub>CE</sub> = 3.0 Vdc, I <sub>C</sub> = 1.0 mAdc)	h <sub>ie</sub>	–	3.5	–	kΩ
Open Circuit Output Impedance (V <sub>CE</sub> = 3.0 Vdc, I <sub>C</sub> = 1.0 mAdc)	h <sub>oe</sub>	–	15.6	–	μmhos
Reverse Voltage Transfer Ratio (V <sub>CE</sub> = 3.0 Vdc, I <sub>C</sub> = 1.0 mAdc)	h <sub>re</sub>	–	1.8	–	x10 <sup>–4</sup>
Forward Transfer Admittance (V <sub>CE</sub> = 3.0 Vdc, I <sub>C</sub> = 1.0 mAdc, f = 1.0 MHz)	y <sub>fe</sub>	–	31–j1.5	–	–
Input Admittance (V <sub>CE</sub> = 3.0 Vdc, I <sub>C</sub> = 1.0 mAdc, f = 1.0 MHz)	y <sub>ie</sub>	–	0.3 + j0.04	–	–
Output Admittance (V <sub>CE</sub> = 3.0 Vdc, I <sub>C</sub> = 1.0 mAdc, f = 1.0 MHz)	y <sub>oe</sub>	–	0.001 + j0.03	–	–
Current–Gain – Bandwidth Product (V <sub>CE</sub> = 3.0 Vdc, I <sub>C</sub> = 3.0 mAdc)	f <sub>T</sub>	300	550	–	MHz
Emitter–Base Capacitance (V <sub>EB</sub> = 3.0 Vdc, I <sub>E</sub> = 0)	C <sub>eb</sub>	–	0.6	–	pF
Collector–Base Capacitance (V <sub>CB</sub> = 3.0 Vdc, I <sub>C</sub> = 0)	C <sub>cb</sub>	–	0.58	–	pF
Collector–Substrate Capacitance (V <sub>CS</sub> = 3.0 Vdc, I <sub>C</sub> = 0)	C <sub>Cl</sub>	–	2.8	–	pF

Figure 1. Collector Cutoff Current versus Temperature (Each Transistor)

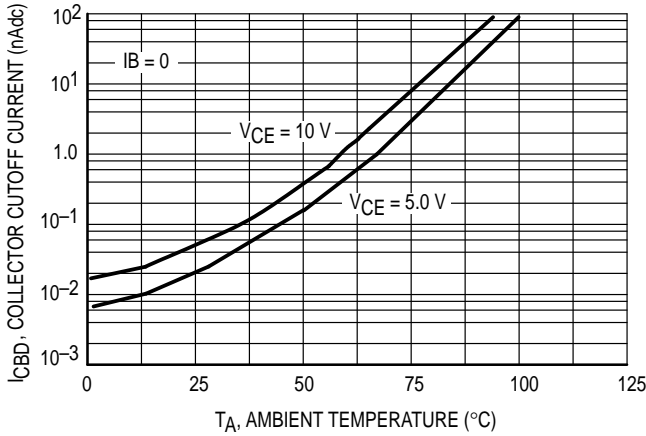

Figure 2. Collector Cutoff Current versus Temperature (Each Transistor)

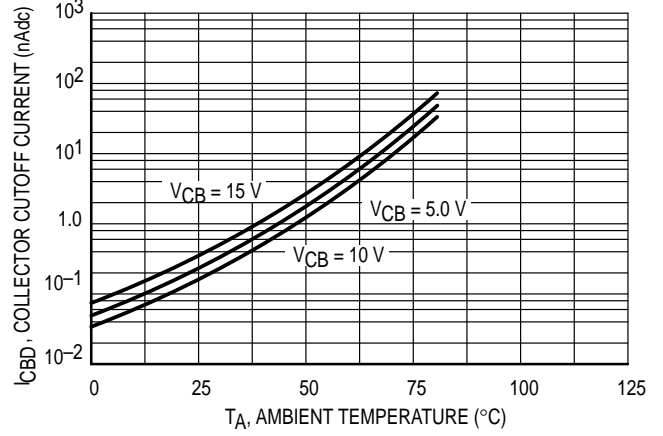

Figure 3. Input Offset Characteristics for Q1 and Q2

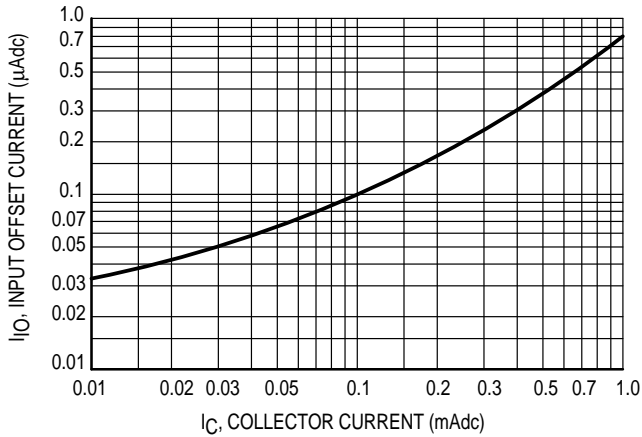

Figure 4. Base-Emitter and Input Offset Voltage Characteristics

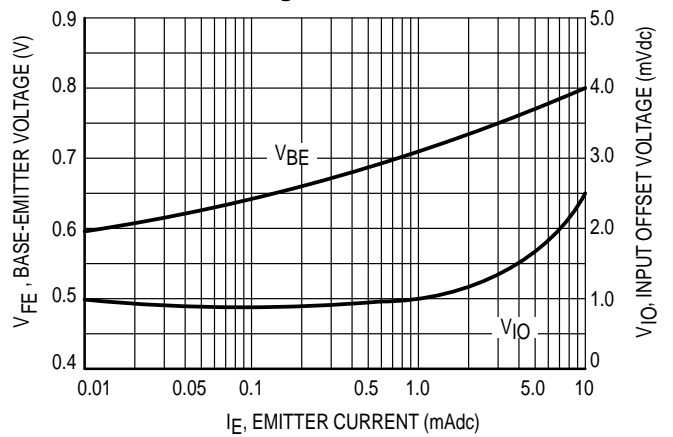
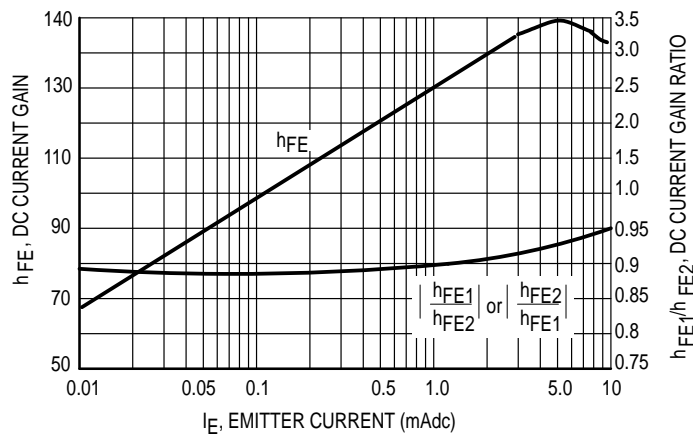

Figure 5. DC Current Gain



# MC3346

## OUTLINE DIMENSIONS

### P SUFFIX PLASTIC PACKAGE CASE 646-06 ISSUE L

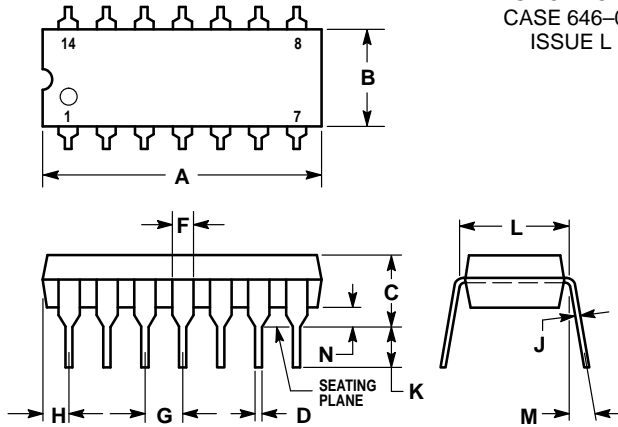

NOTES:

- LEADS WITHIN 0.13 (0.005) RADIUS OF TRUE POSITION AT SEATING PLANE AT MAXIMUM MATERIAL CONDITION.
- DIMENSION L TO CENTER OF LEADS WHEN FORMED PARALLEL.
- DIMENSION B DOES NOT INCLUDE MOLD FLASH.
- ROUNDED CORNERS OPTIONAL.

DIM	INCHES		MILLIMETERS	
	MIN	MAX	MIN	MAX
A	0.715	0.770	18.16	19.56
B	0.240	0.260	6.10	6.60
C	0.145	0.185	3.69	4.69
D	0.015	0.021	0.38	0.53
F	0.040	0.070	1.02	1.78
G	0.100 BSC		2.54 BSC	
H	0.052	0.095	1.32	2.41
J	0.008	0.015	0.20	0.38
K	0.115	0.135	2.92	3.43
L	0.300 BSC		7.62 BSC	
M	0°	10°	0°	10°
N	0.015	0.039	0.39	1.01

### D SUFFIX PLASTIC PACKAGE CASE 751A-03 (SO-8) ISSUE F

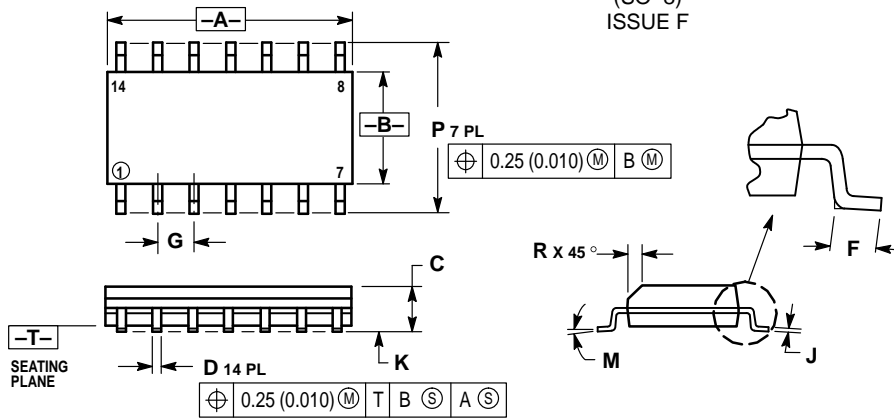

NOTES:

- DIMENSIONING AND TOLERANCING PER ANSI Y14.5M, 1982.
- CONTROLLING DIMENSION: MILLIMETER.
- DIMENSIONS A AND B DO NOT INCLUDE MOLD PROTRUSION.
- MAXIMUM MOLD PROTRUSION 0.15 (0.006) PER SIDE.
- DIMENSION D DOES NOT INCLUDE DAMBAR PROTRUSION. ALLOWABLE DAMBAR PROTRUSION SHALL BE 0.127 (0.005) TOTAL IN EXCESS OF THE D DIMENSION AT MAXIMUM MATERIAL CONDITION.

DIM	MILLIMETERS		INCHES	
	MIN	MAX	MIN	MAX
A	8.55	8.75	0.337	0.344
B	3.80	4.00	0.150	0.157
C	1.35	1.75	0.054	0.068
D	0.35	0.49	0.014	0.019
F	0.40	1.25	0.016	0.049
G	1.27 BSC		0.050 BSC	
J	0.19	0.25	0.008	0.009
K	0.10	0.25	0.004	0.009
M	0°	7°	0°	7°
P	5.80	6.20	0.228	0.244
R	0.25	0.50	0.010	0.019

Motorola reserves the right to make changes without further notice to any products herein. Motorola makes no warranty, representation or guarantee regarding the suitability of its products for any particular purpose, nor does Motorola assume any liability arising out of the application or use of any product or circuit, and specifically disclaims any and all liability, including without limitation consequential or incidental damages. "Typical" parameters which may be provided in Motorola data sheets and/or specifications can and do vary in different applications and actual performance may vary over time. All operating parameters, including "Typicals" must be validated for each customer application by customer's technical experts. Motorola does not convey any license under its patent rights nor the rights of others. Motorola products are not designed, intended, or authorized for use as components in systems intended for surgical implant into the body, or other applications intended to support or sustain life, or for any other application in which the failure of the Motorola product could create a situation where personal injury or death may occur. Should Buyer purchase or use Motorola products for any such unintended or unauthorized application, Buyer shall indemnify and hold Motorola and its officers, employees, subsidiaries, affiliates, and distributors harmless against all claims, costs, damages, and expenses, and reasonable attorney fees arising out of, directly or indirectly, any claim of personal injury or death associated with such unintended or unauthorized use, even if such claim alleges that Motorola was negligent regarding the design or manufacture of the part. Motorola and registered trademarks of Motorola, Inc. Motorola, Inc. is an Equal Opportunity/Affirmative Action Employer.

**How to reach us:**

**USA/EUROPE/Locations Not Listed:** Motorola Literature Distribution; P.O. Box 20912; Phoenix, Arizona 85036. 1-800-441-2447 or 602-303-5454

**MFAX:** RMFAX0@email.sps.mot.com – TOUCHTONE 602-244-6609  
**INTERNET:** <http://Design-NET.com>

**JAPAN:** Nippon Motorola Ltd.; Tatsumi-SPD-JLDC, 6F Seibu-Butsuryu-Center, 3-14-2 Tatsumi Koto-Ku, Tokyo 135, Japan. 03-81-3521-8315

**ASIA/PACIFIC:** Motorola Semiconductors H.K. Ltd.; 8B Tai Ping Industrial Park, 51 Ting Kok Road, Tai Po, N.T., Hong Kong. 852-26629298

